

▪ Florida Association of ▪  
Sinkhole Stabilization Specialists

## **Standard Test Method for Determining the General Levelness of a Floor System**

# **HS-08**

# Standard Test Method HS-08



## Table of Contents

- 1. Title**
- 2. Designation**
- 3. List of Figures**
- 4. Scope**
- 5. Referenced Documents**
- 6. Terminology**
- 7. Summary of Test Method**
- 8. Significance and Use**
- 9. Apparatus**
- 10. Organization of Test Area**
- 11. Procedure**
- 12. Post-Processing and Calculation of Results**

# Standard Test Method HS-08



## 1. Title

Standard Test Method for Determining the General Levelness of a Floor System

## 2. Designation

This standard test method is issued under the fixed designation HS; the number immediately following the designation indicates the year of original adoption or, in the case of revision, the year of last revision. A number in parentheses indicates an editorial. This standard has been peer reviewed and approved for use throughout this industry.

# Standard Test Method HS-08



## 3. List of Figures

- Figure 1: Detailed drawing of a typical manometer apparatus.
- Figure 2: Detailed drawing of a typical gas level apparatus.
- Figure 3: A sketch of the floor plan of a structure.
- Figure 4: Example drawing of measuring device set-up location.
- Figure 5: Sketch showing how to layout test sections and measurement points.
- Figure 6: Sketch of measurement points in a typical room.
- Figure 7: Drawing of the location of points around an area drain.
- Figure 8: Drawing of the location of survey point for tile.
- Figure 9: Sketch of the layout of measurement points when obstructions are encountered.
- Figure 10: Drawing of location of survey points for a threshold.
- Figure 11: Drawing of location of survey points around a crack.
- Figure 12: Drawing of location of survey points at an elevation step down.
- Figure 13: Sketch showing how to read an adjusted manometer.
- Figure 14: CAD representation of the horizontal surface survey data sheet.
- Figure 15: Plan view of threshold measurements.
- Figure 16: A manhole rim used as an external reference point.
- Figure 17: Plan view of a structure using computer-aided design (CAD).
- Figure 18: Plan view of a structure with step-down lines and notations shown.
- Figure 19: Partial plan view of a structure with survey point locations shown.

## Standard Test Method HS-08



Figure 20: Example of multiple test surfaces with origins shown.

Figure 21: Completed topographical plan view of a structure.

# Standard Test Method HS-08



## 4. Scope

- 4.1 This test method provides a quantitative method of measuring collecting elevation measurements over a floor system to evaluate the surface's general degree of levelness using the U.S. customary system (USCS) of units in inches.
- 4.2 This standard does not purport to address all of the safety concerns, if any, associated with its use. It is the responsibility of the user of this standard to establish appropriate safety and health practices and determine the applicability of regulatory limitations prior to use.

# Standard Test Method HS-08



## 5. Referenced Documents

- 5.1 ASTM Standard: E 1155 (General Compliance)
- 5.2 ACI Standard: ACI 117-90 Standard Specifications for Tolerances for Concrete Construction Materials.
- 5.3 Data Collection: Manufacturer's Recommendations for Pro-Level Water Level ®.
- 5.4 Computer Aided Analysis: AutoCAD® and Surfer®.
- 5.5 Gas Level User Guide: ZIPLEVEL PRO-2000™

# Standard Test Method HS-08

## 6. Terminology

### 6.1 Definitions of Terms Specific to This Standard:

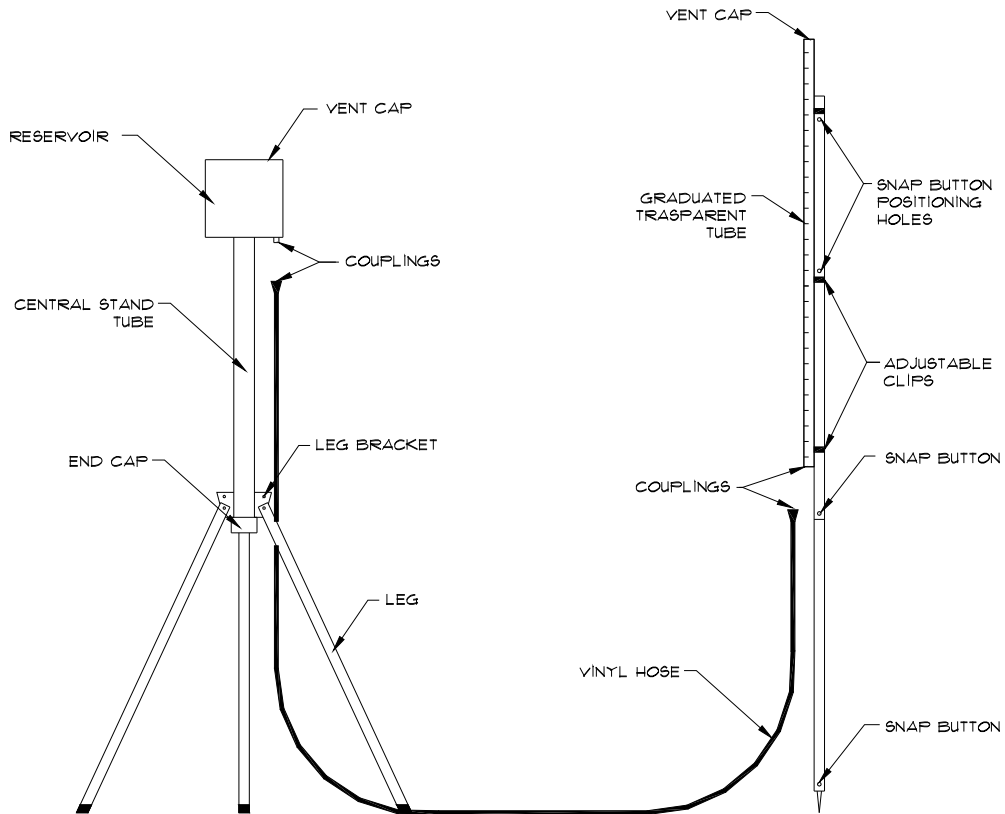

**Figure 1: Detailed drawing of a typical manometer apparatus.**



# Standard Test Method HS-08

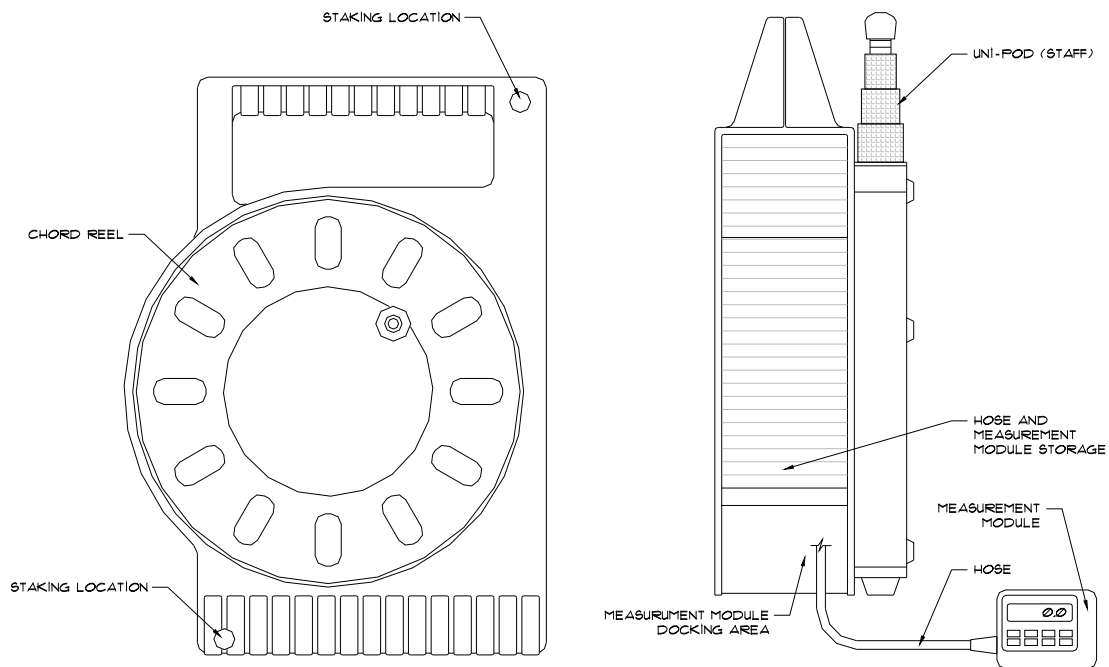

**Figure 2: Detailed drawing of a typical gas level apparatus.**

- 6.1.1 Elevation - Height, altitude, and/or vertical location in space. Elevation measurements are always made parallel to the direction of gravity.
- 6.1.2 Flat - Even, plane, and free of undulation.
- 6.1.3 Horizontal - Normal to the direction of gravity.
- 6.1.4 Manometer - A measuring device which utilizes free liquid that measures the elevations of points within a horizontal surface (see Figure 1).
- 6.1.5 Gas Level - A measuring device which utilizes a contained gas that measures the elevations of points within a horizontal surface (see Figure 2).

# Standard Test Method HS-08



- 6.1.6 Level – Horizontal; normal to the direction of gravity.
- Discussion - For the purposes of this test method, levelness will be evaluated by collecting elevation measurements at points spaced apart according to standard specifications (see Sections 10 and 11).
- 6.1.7 Sign Convention - Where up is the positive direction; down is the negative direction. Consequently, the higher the reading point, the more positive its Zi value, and the lower the reading point, the more negative its Zi value. Similarly, the elevation difference from a low point to a high point (that is, an upward difference) is positive, while the elevation difference from a high point to a low point (that is, a downward difference) is negative.
- 6.1.8 Test Surface - On any one structure level, the entire surface area of interest constitutes the test surface, with the limitations listed in Section 10.
- 6.1.9 Vertical - Parallel to the direction of gravity.
- 6.1.10 Flooring – The floor surface covering within a room.
- 6.1.11 Obstruction – An object that stands in the way and must be circumvented.
- 6.1.12 Benchmark – The measurement device’s location; the origin location by which all measurements are taken and relative.
- 6.1.13 Threshold – The point where two different flooring types or elevations or planes meet.
- 6.1.14 Step-down – A vertical elevation difference between two planes.
- 6.1.15 Bench Plane – Recorded measurements on the same level as the benchmark.
- 6.1.16 Reference Point – An internal or external data point used as a fixed reference for future.
- 6.1.17 Data Points – The plan location corresponding to the various elevation readings.

# Standard Test Method HS-08



## 6.2 Symbols Specific to This Standard:

- 6.2.1 [B] – Elevation at the location of the measuring device.
- 6.2.2 [i] – Designation of each elevation point.
- 6.2.3 [n<sub>i</sub>] – Number of reading points in Test Sample i.
- 6.2.4 [P<sub>i</sub>] – Elevation (in inches) at each measurement point.
- 6.2.5 [Z<sub>i</sub>] – Adjusted elevation points including thresholds.
- 6.2.6 [T] – Difference between two points on different test surfaces separated by a threshold.

## 6.3 Field Note Nomenclature

- 6.3.1 [D] – Door
- 6.3.2 [W] – Window
- 6.3.3 [SGD] – Sliding Glass Door
- 6.3.4 [OHD] – Overhead Door (Garage Door)
- 6.3.5 [FD] – Front Door
- 6.3.6  Benchmark
- 6.3.7 [R] – External Reference Point.

# Standard Test Method HS-08



## 7. Summary of Test Method

- 7.1 Horizontal surfaces are divided into test areas. Elevation measurements at data points are then collected according to methods discussed in Section 10. The elevation differences are calculated between each point and the benchmark. The floor plan and data points may be drafted in a CAD program and the XY coordinates recorded. Relative Z values are calculated. The XYZ data is inputted into a computer software program capable of producing topographic maps. Generated topographic maps of the examined surface are imported into the CAD environment and compiled with the drafted structure. Alternatively, the elevation data may be plotted and contoured manually. This topographic map is used as a visual aid to assist the engineer in diagnosing and/or resolving potential structural issues.

# Standard Test Method HS-08



## 8. Significance and Use

- 8.1 This test method provides graphical information concerning horizontal surface profiles.
- 8.2 Results of this test are used primarily as:
  - 8.2.1 A diagnostic tool that may assist in the identification of areas of a structure that may have been subject to vertical displacement and is primarily utilized for reference only.
  - 8.2.2 An assessment tool to evaluate the amount of relative elevation change to any portion of the structure.

Discussion: Given that elevation patterns across a horizontal surface may vary, random samplings of the surface may be required for accurate representation since it is not feasible to measure the infinite number of potential profiles.

- 8.3 Results of this survey are not intended to represent a geodetic survey and are not based on NGVD 1929 data. This survey may not reflect isolated and/or small imperfections / discontinuities. It should be emphasized the floor elevation survey provides a measurement of relative elevation changes across the study area at the time the survey data was collected.

# Standard Test Method HS-08



## 9. Apparatus

### 9.1 Point Elevation Measurement Devices (PEMD):

9.1.1 Type I Apparatus - An apparatus capable of measuring the elevations of a series of points according to standard specifications spaced in a set pattern on the horizontal surface. Examples of satisfactory Type I point elevation measurement devices include, but are not limited to:

9.1.1.1 Manometer - A device that measures the elevations of a horizontal surface using the basic principle of fluid equalizing at the same elevation on both sides of a U-shaped tube.

9.1.1.2 Gas Level - A device that measures the elevations of a horizontal surface through calculation of differential gas pressure between the base unit and measurement module.

9.1.1.3 Optical Level - A device that measures the elevation from a transit to a scaled target.

Discussion: This is a device that is limited by line of sight and is suitable for open areas only. Use of line of sight devices may not be practical for interior built out environments.

9.1.1.4 Laser Level - A device that measures the elevation from a rotary laser to a scaled target.

Discussion: This is a device that is limited by line of sight and is suitable for open areas only. Use of line of sight devices may not be practical for interior built out environments.

9.1.2 If a Type I apparatus (see 9.1.1) is not used for this test, then an apparatus capable of measuring the elevations of a series of points spaced in a set pattern according to standard specifications on the horizontal surface shall be used. Carpenter's level, string lines or taut wires are not suitable devices for use when measuring the elevation for a series of points.

# Standard Test Method HS-08



## 9.2 Ancillary Equipment:

- 9.2.1 Measurement Tape, graduated in fractions of inches
- 9.2.2 Data Recording Means - This procedure requires the recording of both verbal and numeric information. Examples of satisfactory data recording methods include:
  - 9.2.2.1 Manual Data Sheet.
  - 9.2.2.2 Magnetic or Digital Tape Recorder (voice or direct input).
  - 9.2.2.3 Paper Chart Recorder.
  - 9.2.2.4 Direct Computer Input.

# Standard Test Method HS-08



## 10. Organization of Test Area

- 10.1 Test Surface – Any one level, the entire horizontal floor surface of interest shall constitute the test surface.
- 10.2 Test Section – A test section shall consist of any subdivision of a test surface satisfying the following criteria.
  - 10.2.1 A test section is determined by a change in original construction surface continuity, walls, or some other physical boundary.
  - 10.2.2 No portion of the test section shall be associated with more than one test surface.
- 10.3 Threshold – Location in which two different surfaces intersect.
  - 10.3.1 Measurement points taken at a threshold are to comply with standards discussed in Section 11.1.
- 10.4 Record the name and project number of the subject structure, the date of the inspection, and the personnel involved in conducting the survey.
- 10.5 Lay out the test surface.
  - 10.5.1 Sketch the structure on graph paper. At the discretion of the engineer, note on the sketch the placement of doors, windows, and slab cracks, as well as the structure type; i.e. frame walls or masonry walls.



# Standard Test Method HS-08

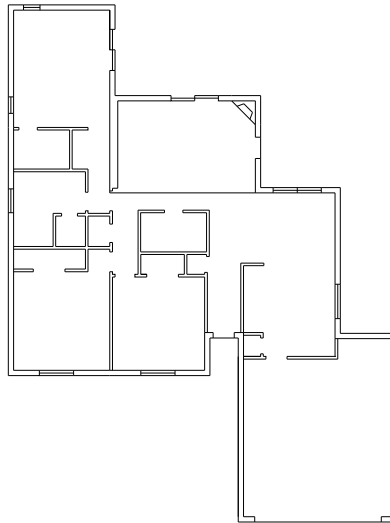

**Figure 3: A sketch of the floor plan of a structure.**

10.5.2 Dimension the structure. Use appropriate notations when dimensioning and labeling doors and windows (see Section 6.3). Record these dimensions on the sketch, ensuring that dimensions are notated correctly.

10.5.3 Evaluate the test area and determine the ideal location for the measuring device (typically centralized in the structure). The hose should reach the entire structure, as well as an external reference point (see Section 11.4). If the structure is too large for the hose to reach the entire surface, refer to Section 11.2 for back stationing standards.

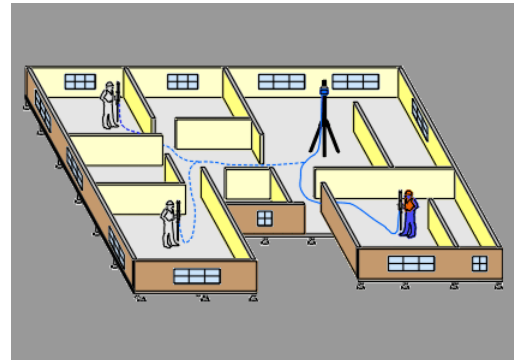
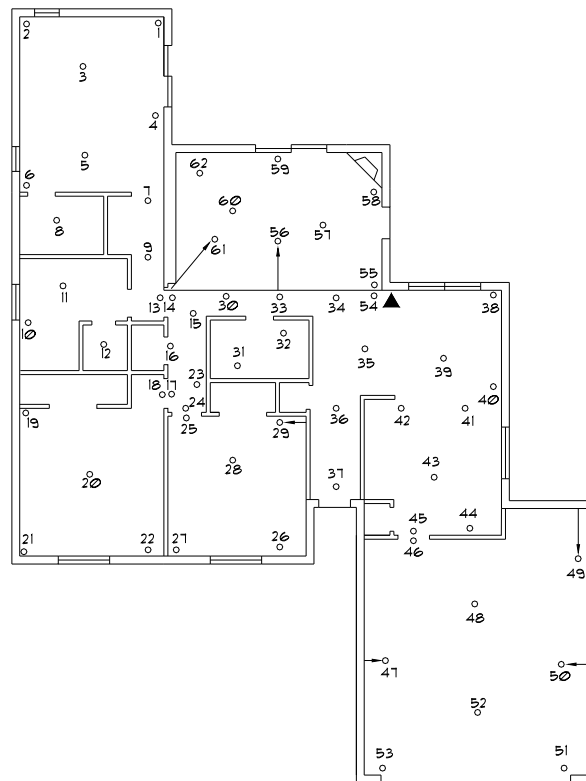

**Figure 4: Example drawing of measuring device set up location.**

# Standard Test Method HS-08



- 10.5.4 All elevation changes at thresholds and different floor construction types (patio, porches, sunken living rooms, garages, etc.) shall be treated as separate test sections.
- 10.5.5 Determine the number and location of all data points to be used in each test section. At the discretion of the engineer, assign a different identification number to each data points and record the locations of all data points. Mark or otherwise physically delineate each data point's location on the sketched floor plan of the structure. Equivalent methods of data collection are acceptable.

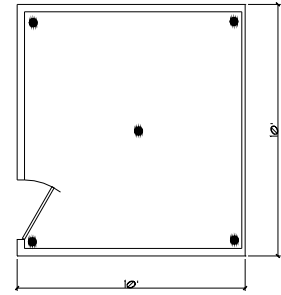

**Figure 5: Sketch showing how to layout test sections and measurement points.**

# Standard Test Method HS-08



- 10.5.6 Data points shall be determined based on the following guidelines:
- Maximum surface area per point is 100 ft<sup>2</sup>. This area is based on measurements within a 10 ft x 10 ft grid.
  - Maximum spacing between measurements is 10 ft.
  - If the room is less than 50 ft<sup>2</sup> a minimum of 3 measurements are to be taken.
  - If the room is between 50 ft<sup>2</sup> and 120 ft<sup>2</sup> a minimum of 4 measurements are to be taken.
  - If the room is more than 120 ft<sup>2</sup> a minimum of 5 measurements are to be taken.
  - A minimum of 3 measurements taken per room or test section, where practical.



**Figure 6: Sketch of measurement points in a typical room.**

10.5.7 Exceptions to the above guidelines in section 10.5.6 are as follows (as applicable):

- A reach-in closet is to have a minimum of one measurement.
- One measurement is to be taken at each corner of all roof equipment or concentrated roof loads.
- Four measurements are to be taken at the invert elevation of an area drain and four measurements to the perimeter.

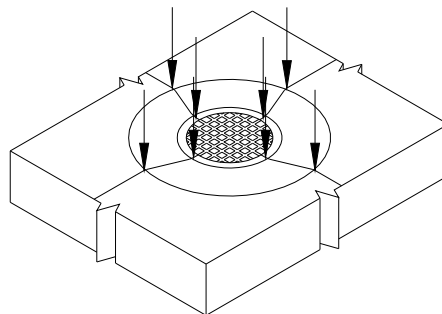

**Figure 7: Drawing of the location of points around an area drain.**

# Standard Test Method HS-08



## 11. Procedure

### 11.1 Taking Measurements

- 11.1.1 Record the first data point as close to the measuring device as possible. This point is the benchmark, and all other points are taken relative to this point. Record the benchmark level on the floor survey data sheet.

Discussion: When using a Gas Level this benchmark point is to be verified fifteen minutes after the start of the survey to establish that the Apparatus has reached equilibrium with the ambient room temperature.

- 11.1.2 Treat every test surface as a unique entity and take measurements respective to its plane.
- 11.1.3 At the engineer's discretion, when taking measurements on carpeted area, use the staff to puncture through carpeting until the slab or substrate is reached while avoiding the carpet's tack strip. When measurements are taken on a tile finished surface, take survey point in the grout line of the tile.

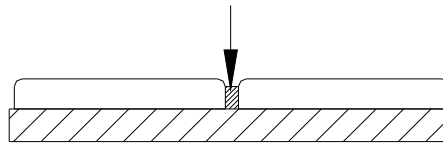

**Figure 8: Drawing of the location of a survey point for tile.**

- 11.1.4 Take measurements at points assigned (see Section 10.5.5) and record the measurement in the appropriate field on the floor survey data sheet.

# Standard Test Method HS-08



When taking sample measurements on a defined test surface exhibiting obstructions, the following guidelines are suggested (see also Section 11.3.6):

- When any obstructions are encountered, draw an arrow on the field sketch showing direction of the offset so that the data point can accurately be positioned on the final plot.
- Corner perimeter obstructions - Take a measurement at a 45° angle from the corner. Record the distance off of the corner of the wall in the “diagonal offset” column on the floor survey data sheet and check the “perimeter obstruction” box.
- Side perimeter obstructions - Record the distance from the wall in the “perpendicular offset” column and check the “perimeter obstruction” box.
- Center obstructions - Take a measurement as close to the center as possible. Record the distance from the true center of the test surface in the diagonal or perpendicular offset column and check the “center obstruction” box.
- Offset distances should be recorded within +/- 6 inches of their location in the field to provide accurate mapping.

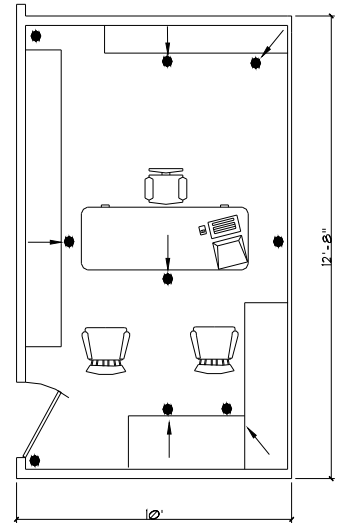

**Figure 9: Sketch of the layout of measurement points when obstructions are encountered.**

Discussion: When a large number of obstructions are encountered, a note to that effect should be placed on the final plan.

- 11.1.5 When the floor finish of a test surface changes, take a threshold measurement. This includes a measurement point adjacent to each side of the threshold.

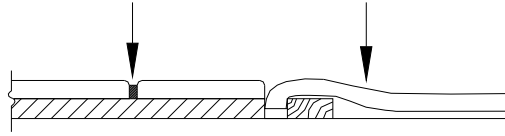

**Figure 10: Drawing of location of survey points for a threshold.**

- 11.1.6 Increase the number of measurement points along and across cracks to sufficiently define the discontinuities as possible and practical and at the direction of the engineer.

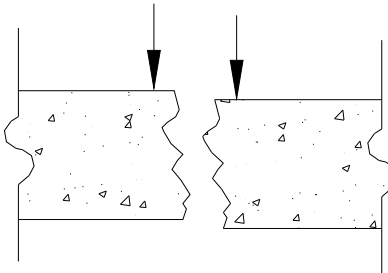

**Figure 11: Drawing of location of survey points around a crack.**

- 11.1.7 Always take at least one data point on both sides of an elevation change.

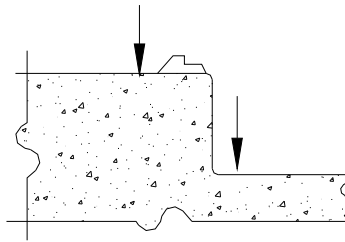

**Figure 12: Drawing of location of survey points at an elevation step down.**

Discussion: If an elevation difference is significant enough that, a new benchmark is needed a note to that effect should be placed on the final plan.

- 11.1.8 In areas not covered by the exceptions and not containing sufficient head room, back-stationing is to be considered (see Section 11.2).

# Standard Test Method HS-08



## 11.2 Back-stationing

11.2.1 Back-stationing is incorporated when the hose will not reach the entire test surface and/or there is insufficient headroom.

### 11.2.2 Manometer Back-stationing

11.2.2.1 A data point is taken and recorded as discussed in Section 11.3. The manometer is then moved to the desired location within the test area. The same measurement point that was previously taken is then taken again. The following data points taken in the new test area are adjusted so that the two data points taken at the same location are equal.

11.2.2.2 When headroom is insufficient, the manometer can be adjusted to fit in smaller areas as shown in Figure 13.

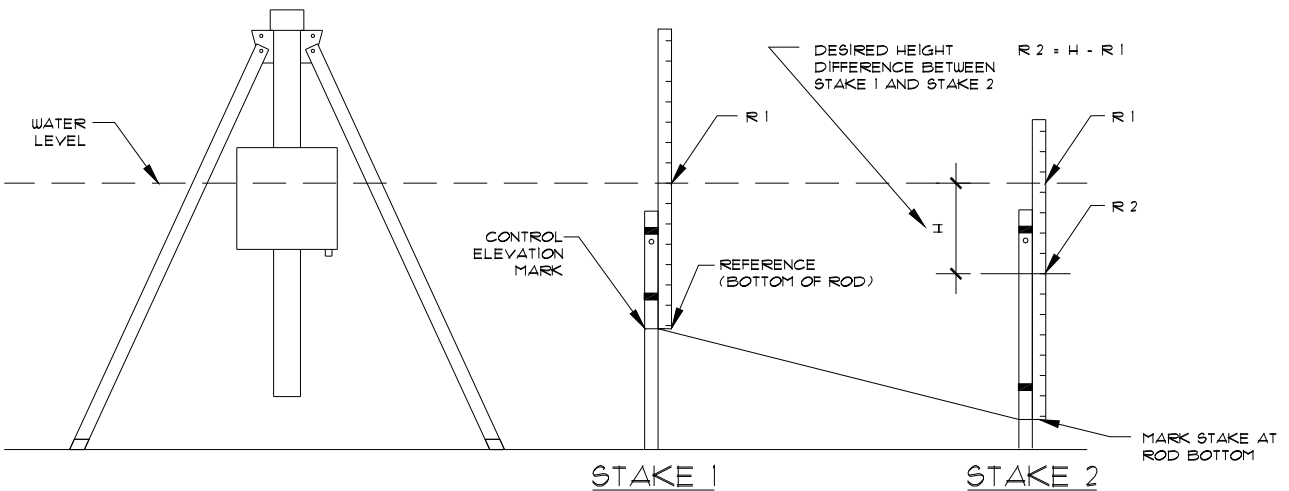

**Figure 13: Sketch showing how to read an adjusted manometer.**

# Standard Test Method HS-08



## 11.3 Recording Data

- 11.3.1 At the discretion of the engineer, the data for each data point is recorded on the floor survey data sheet. This includes the elevation of each point, the finish of the surface where each point is taken, step down information, and obstruction information. Alternatively, the data can be directly recorded on the base map.
- 11.3.2 The floor survey data sheet should include the following items: data point numbers, point elevations, type of floor finish, step downs, obstructions, and XYZ data columns.

Discussion: It is important that **all** information is recorded. Be sure to mark step-downs so that when the contour lines are created, the creator will be able to decipher the separate topographies and where they are located.



# Standard Test Method HS-08

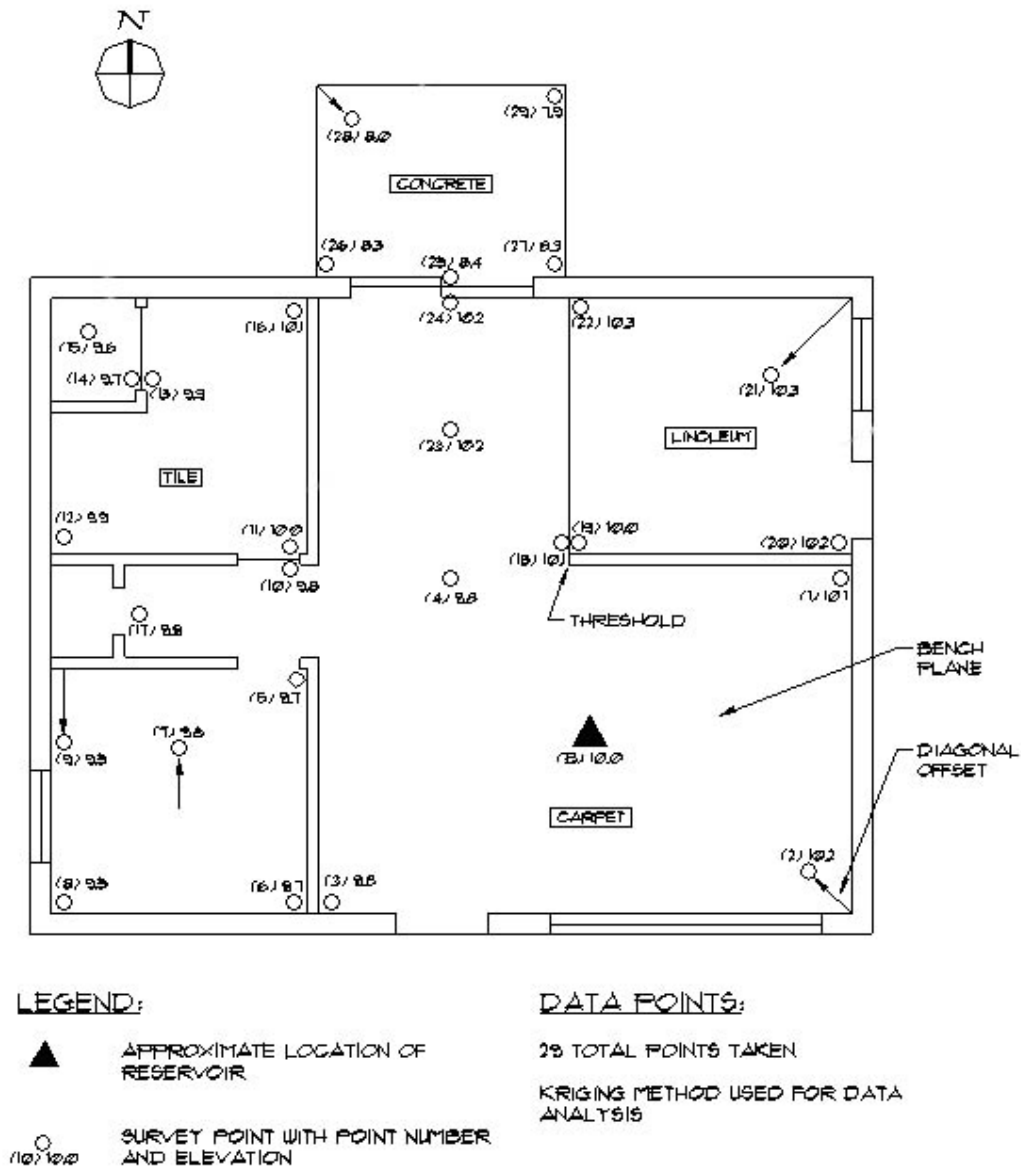

Figure 14: CAD representation of the floor survey data sheet.

# Standard Test Method HS-08



- 11.3.3 The first measurement point will always be your benchmark elevation. Record this elevation in the bench plane. The elevation for each measurement point on the same plane as the bench is recorded in the bench plane.
- 11.3.4 When a measurement point is taken, the surface finish where the point is taken should also be recorded.
- 11.3.5 When a threshold is encountered, begin recording elevations in the next plane and relative to that plane.
  - 11.3.5.1 When all points in a plane are accounted for, return to a previous plane. If another threshold exists, continue recording elevations in the next plan.

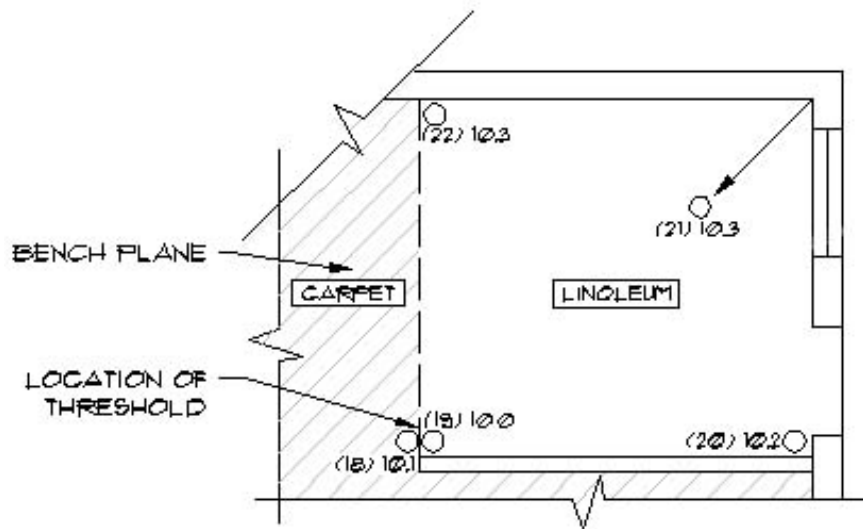

Figure 15: Plan view of threshold measurements.

# Standard Test Method HS-08



- 11.3.6 Any obstructions encountered are to be noted, where necessary.
  - 11.3.6.1 Record and notate the distance of perpendicular or diagonal offsets in inches.
  - 11.3.6.2 On the sketch of the structure, note all offsets with an arrow in the direction of the offset.

## 11.4 External Reference Point – [R]



**Figure 16: A manhole rim used as an external reference point.**

- 11.4.1 At the discretion of the engineer, an external data point can be utilized as a fixed reference for future surveys. This data point is taken from an object that will remain stationary relative to any movement of the structure.
- 11.4.2 Objects used for external reference points include, but are not limited to:
- The rim of a manhole.
  - The back of the curb where it meets the driveway.
  - A surveyor's mark.
- 11.4.3 A description and location of the external reference point is to be provided on the final graphic.

## 12. Post-Processing and Calculation of Results

### 12.1 Topography Drafting Standards

#### 12.1.1 Drafting the Structure

- 12.1.1.1 If using Computer Aided Design (CAD) software, prepare a floor plan using standard widths for wall thicknesses (CMU, frame, brick, etc.).

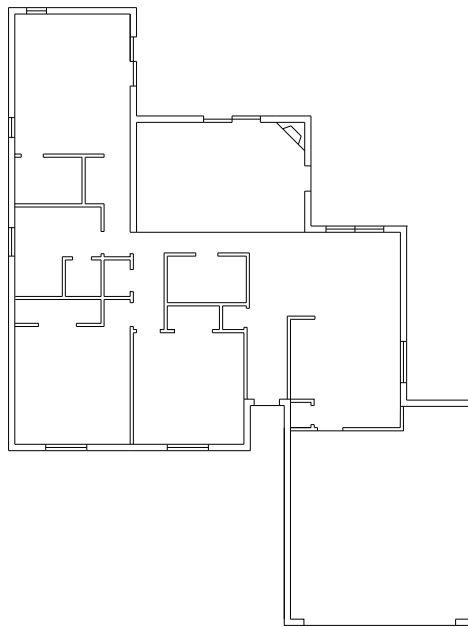

**Figure 17: Plan view of a structure using computer-aided design (CAD).**

- 12.1.1.2 When step-downs are encountered, a line should be drawn to designate the location of the step down. All step-downs should have the step-down notation with the vertical offset notated.

# Standard Test Method HS-08

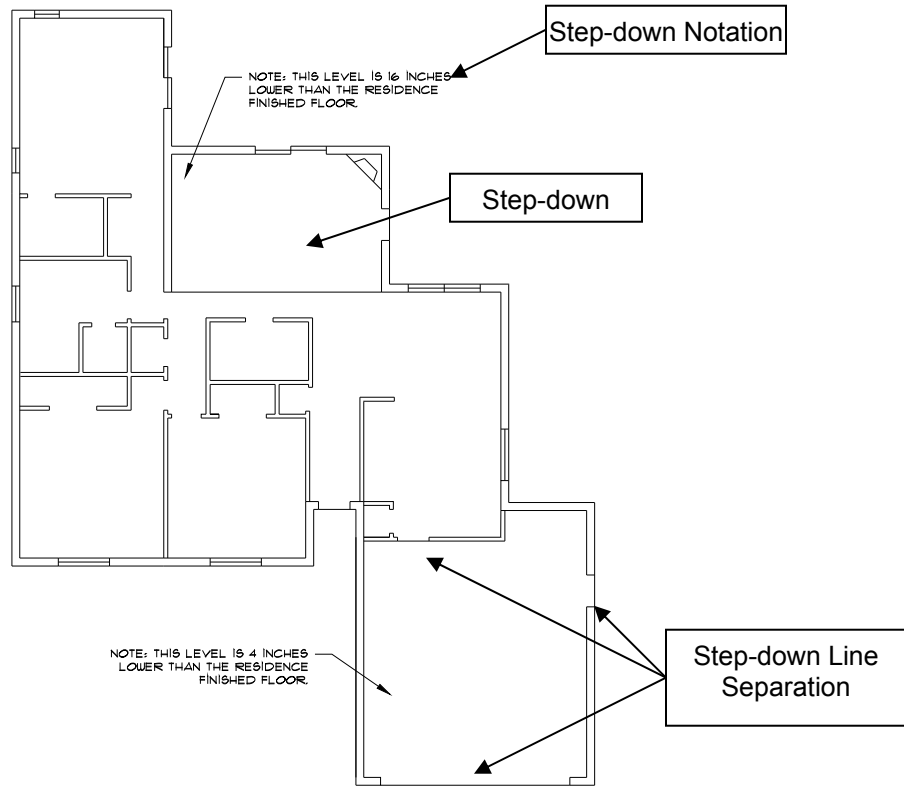

**Figure 18: Plan view of a structure with step-down lines and notations shown.**

## 12.1.2 Placement of Survey Points

- 12.1.2.1 Place all survey points in the plan drawing according to the field sketch in correspondence to the obstructions notated on the floor survey data sheet.

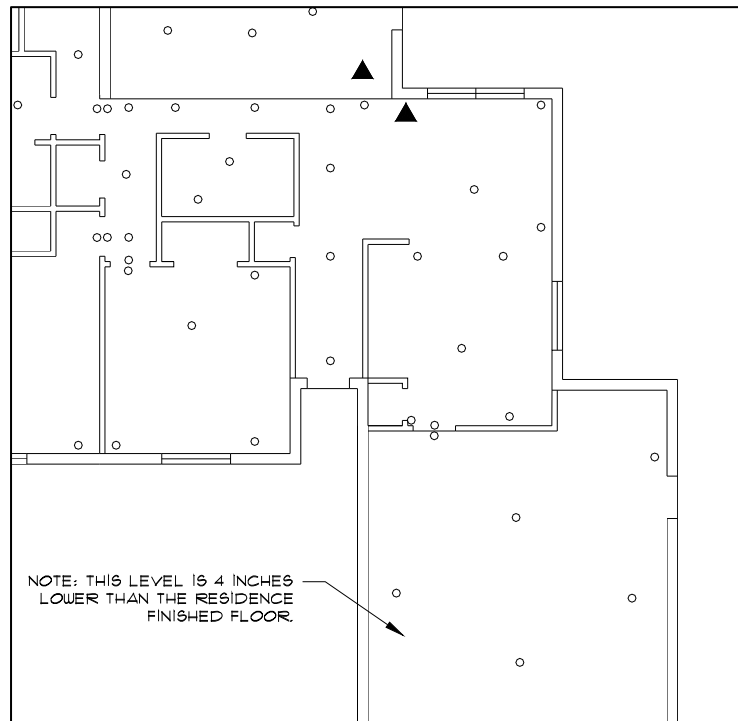

**Figure 19: Partial plan view of a structure with survey point locations shown.**

## 12.1.3 Recording CAD XY-Coordinates

- 12.1.3.1 For each test surface, an independent set of XY-coordinates should be recorded, if CAD software is utilized.

# Standard Test Method HS-08



- 12.1.3.2 Set the CAD origin to the lower left corner of the test section.
- 12.1.3.3 Determine the X and Y coordinates of the survey points and record them on the original floor survey data sheet.
- 12.1.3.4 Repeat steps for all individual test surfaces.
- 12.1.3.5 With the lower-left origin designated as (0'-0", 0'-0"), determine the upper-right-most coordinate for all test surfaces [ie. (24'-7", 32'-2")]. Record and label each test surface boundary on the first page of the original floor survey data sheet.

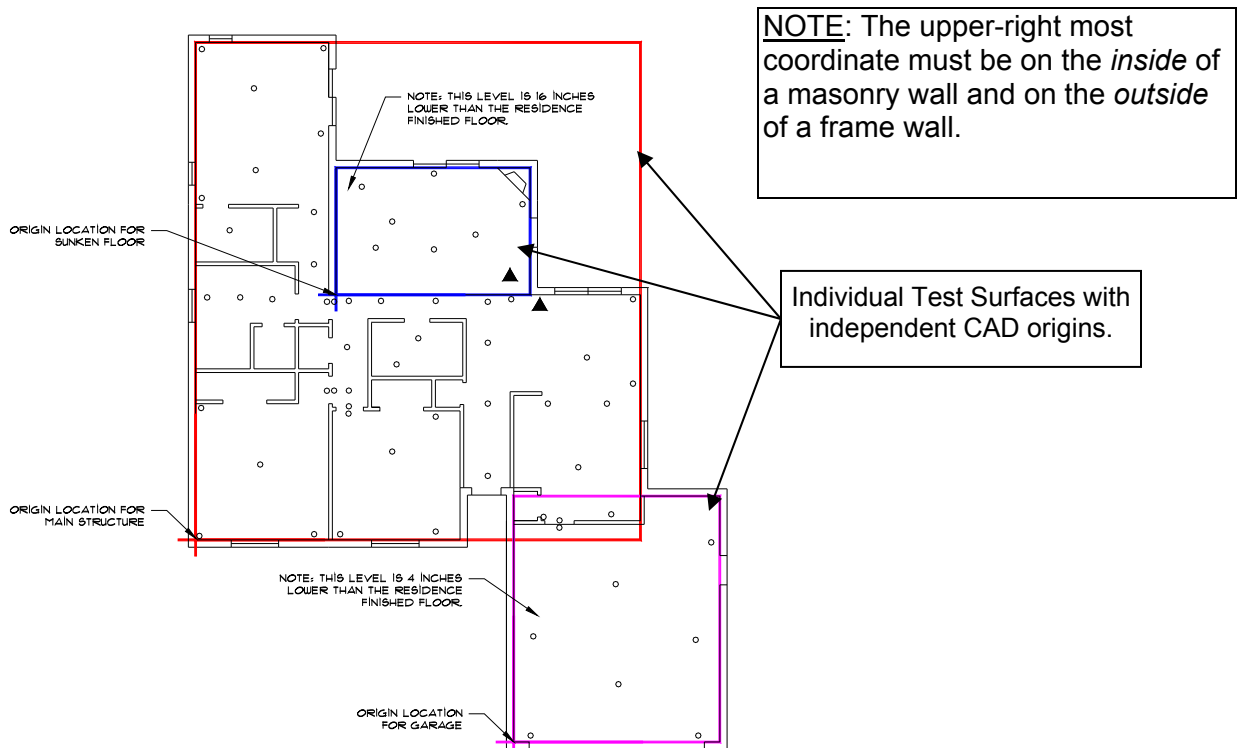

Figure 20: Example of multiple test surfaces with origins shown.



# Standard Test Method HS-08



## 12.2 Data Processing

### 12.2.1 Calculate the relative elevations of all data points:

12.2.1.1 Designate the z-coordinate of the benchmark as zero and adjust the other elevations accordingly by subtracting the bench elevation from each point elevation.

12.2.1.1.1 If a threshold exists between two surfaces, calculate the difference in the two elevations.

12.2.1.1.2 For survey points taken on a test section, subtract the bench elevation from that point and add the difference of the threshold.

## 12.3 Creating the Topographic Map

12.3.1 Using software approved for generation of topographical maps, copy the XYZ information into the program. Create an individual topography for every test surface. Alternatively, manual contouring of the elevation data can be utilized.

12.3.2 Import topographies into CAD software and scale to fit to a 1:1 ratio. The contour line with the highest positive value should be set to 0.4 and the remaining line values adjusted.

12.3.3 Lines should not appear in areas that were not surveyed. Cut topography lines passing through masonry walls and allow lines to continue through frame walls. Cut lines that pass through stairs, fireplaces, and etc. Extend topography lines to exterior masonry lines with overhead doors (OHD), sliding glass doors (SGD), and typical doors (D).

12.3.4 All step-downs should have the standard step-down notation with the correct vertical offset notated.

12.3.5 .Notate the accuracy limits of the survey relative to the apparatus used.

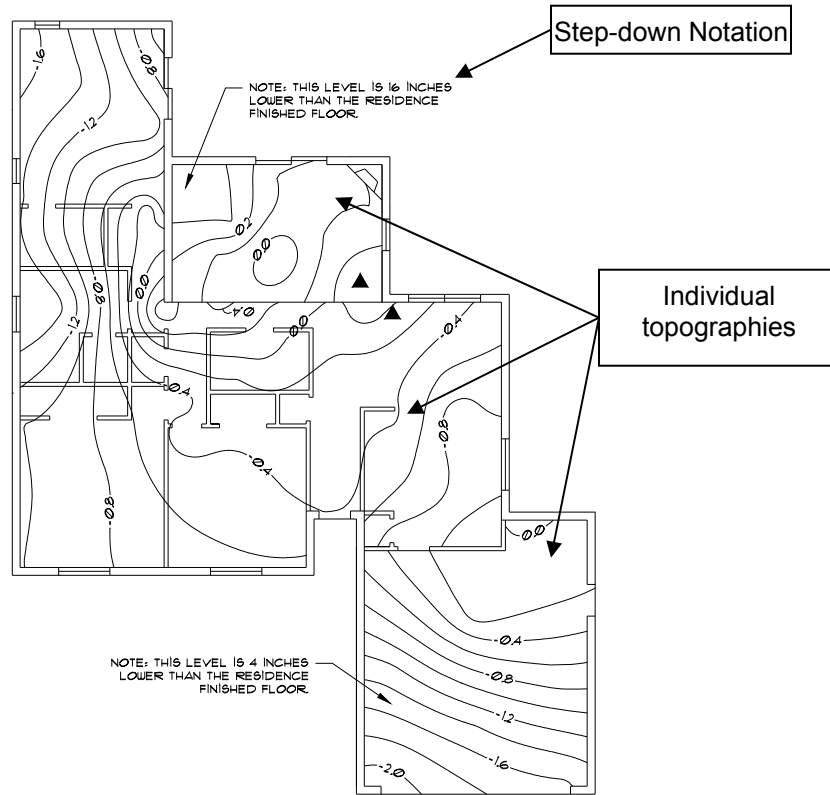

Figure 21: Example topographical plan view of a structure.